

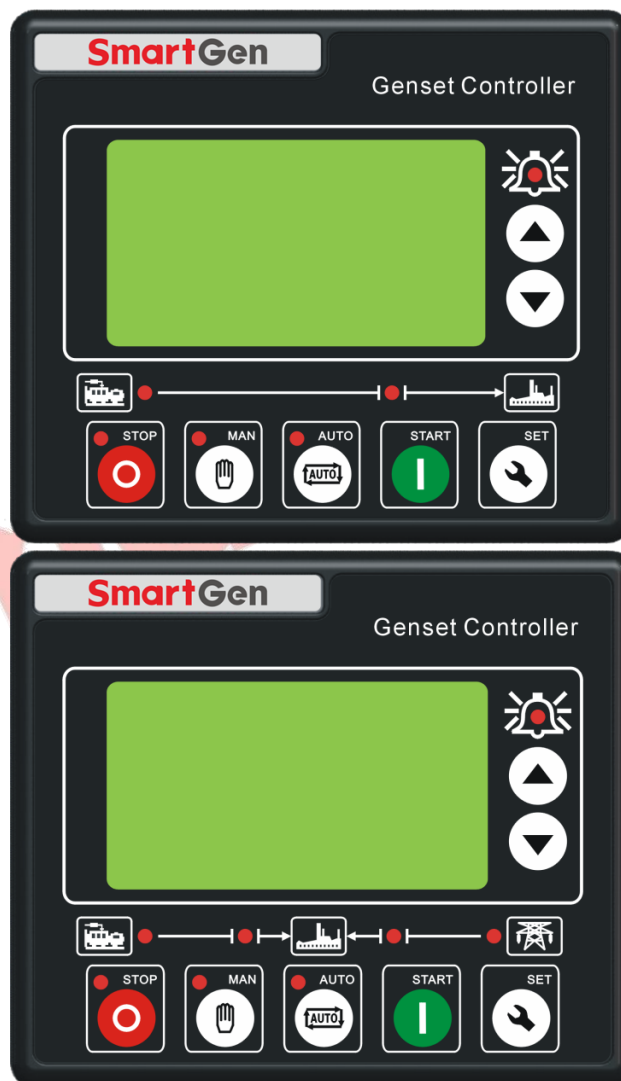

**SmartGen**  
ideas for power

## HGM400 Series Genset Controller (HGM410/HGM420)

### USER MANUAL



ZHENGZHOU SMARTGEN TECHNOLOGY CO.,LTD

# CONTENTS

1	OVERVIEW .....	5
2	PERFORMANCE AND CHARACTERISTICS .....	6
3	SPECIFICATION .....	8
4	OPERATION.....	9
4.1	PUSHBUTTONS.....	9
4.2	INDICATOR LIGHT .....	10
4.3	AUTOMATIC START/STOP OPERATION.....	11
4.4	MANUAL START/STOP OPERATION.....	12
5	PROTECTION .....	13
5.1	WARNINGS.....	13
5.2	SHUTDOWN ALARM.....	16
6	CONNECTIONS .....	19
7	DEFINITION AND RANGE OF PARAMETERS.....	22
7.1	PARAMETER CONTENTS AND RANGE (TABLE 1).....	23
7.2	PROGRAMMABLE OUTPUT 1-5 (TABLE 2).....	31
7.3	PROGRAMMABLE INPUT 1-4 TABLE (ACTIVE WHEN CONNECT GND (B-) (TABLE 3).....	32
7.4	SENSOR SELECT (TABLE 4).....	34
7.5	CONDITIONS OF CRANK DISCONNECT (TABLE 5).....	35
8	PARAMETERS SETTING .....	36
9	SENSOR SETTING .....	37
10	COMMISSIONING .....	38
11	TYPICAL APPLICATION .....	39
12	INSTALLATION .....	41
12.1	FIXING CLIPS .....	41
12.2	OVERALL DIMENSION AND PANEL CUTOUT.....	42
13	FAULT FINDING .....	44

## 1 OVERVIEW

**HGM400** series genset controllers integrate digitization, intelligentization and network technology which are used for genset automation and monitor control system of single unit to achieve automatic start/stop, data measurement, alarm protection and “three remote” (remote control, remote measuring and remote communication; SG485 module must be fitted). It fit with LCD display, optional languages interface (Chinese, English, Spanish, Turkish and Russian), and it is reliable and easy to use.

**HGM400** series genset controllers adopt micro-processor technology with precision parameters measuring, fixed value adjustment, time setting and set value adjusting and etc. All parameters can be configured from front panel or through programmable interface (USB to LINK, SG72 adaptor produced by Smartgen is recommended) via PC. It can be widely used in all types of automatic genset control system with compact structure, advanced circuits, simple connections and high reliability.

## 2 PERFORMANCE AND CHARACTERISTICS

- **HGM400** series controller has two types:
  - HGM410:** ASM (Automatic Start Module), it controls generator to start/stop by remote signal;
  - HGM420:** AMF (Auto Mains Failure), updates based on HGM410, moreover, has mains electric quantity monitoring and mains/generator automatic transfer control function, especially for automatic system composed by generator and mains.
- 132x64 LCD with backlight, selectable language interface (Chinese, English, Spanish, Turkish and Russian), push-button operation;
- Suitable for 3-phase 4-wire, 3-phase 3-wire, single phase 2-wire, and 2-phase 3-wire systems with voltage 120/240V and frequency 50/60Hz;
- Collects and shows 3-phase voltage, current, power parameter and frequency of generator or mains.

### Mains

Line Voltage (Uab, Ubc, Uca)

Phase Voltage (Ua, Ub, Uc)

Frequency (HZ)

### Generator

Line Voltage (Uab, Ubc, Uca)

Phase Voltage (Ua, Ub, Uc)

Frequency (HZ)

### Load

Current (IA, IB, IC)

Active Power (KW)

Reactive Power (KVar)

Apparent Power (KVA)

Power Factor (PF)

Accumulated Energy (kWh)

- For Mains, controller has over voltage, under voltage and loss of phase detection functions; For generator, controller has over voltage, under voltage, over frequency, under frequency and over current detection functions;
- Precision collect and display parameters about Engine,
  - Temp. (WT)                      °C/°F both be displayed
  - Oil pressure (OP)              kPa/Psi/Bar all be displayed

Fuel Level (FL)           **% (Unit)**

Engine Speed (RP)       **RPM (Unit)**

Battery Voltage (VB)     **V (unit)**

Charger Voltage (VD)    **V (unit)**

Hours Counter (HC): Max. 999999 hours

Start times: Max.999999 times











- Control & Protection: automatic start/stop of the genset, ATS(Auto Transfer Switch) control with perfect fault indication and protection function;
- With ETS(Energize To Stop), idle control, pre-heat control, speed raise control and speed drop control function, All output ports are relay-out;
- Parameter setting: parameters can be modified and cannot be lost even in case of power outage; all the controller parameters can be adjusted using front panel of the controller or via PC using an SG72 adaptor.
- Multiplex input port 3 and 4 can be used in various fields: input 3 can be used as auxiliary input port or fuel level sensor while input 4 can be used as auxiliary input port or configurable sensor.
- More kinds of curves of temperature, oil pressure, fuel level can be used directly and users can define the sensor curves by themselves;
- Configurable sensor: can be set as temperature sensor, oil pressure sensor or fuel level sensor, enable the detection of double temperature, double oil-pressure and double fuel level.
- Multiple crank disconnect conditions (magnetic pickup, oil pressure, generator frequency) are optional;
- Widely Power supply range: DC(8~35)V, suitable to different start battery voltage environment.
- All parameters used digital adjustment, instead of conventional analog modulation with normal potentiometer, more reliability and stability;
- Modular design, self-extinguished ABS plastic enclosure, pluggable connection terminals and embedded installation way; compact structure with easy mounting.

### 3 SPECIFICATION

Items	Contents
Working Voltage	DC8. 0V to 35. 0V, Continuous Power Supply.
Overall Consumption	<3W(Standby mode: ≤2W)
AC voltage Input: 3 Phase 4 Wire 2 Phase 3 Wire Single phase 2 Wire 3 Phase 3 Wire	AC15V - AC360V (ph-N) AC15V - AC360V (ph-N) AC15V - AC360V (ph-N) AC30V - AC620V (ph-ph)
Alternator Frequency	50Hz/60 Hz
Speed Sensor Voltage	1.0V to 24V (RMS)
Speed Sensor Frequency	10,000 Hz (max)
Start Relay Output	5A DC28V power supply
Auxiliary Relay Output 1	5A DC28V power supply
Auxiliary Relay Output 2	5A DC28V power supply
Auxiliary Relay Output 3	5A DC28V power supply
Auxiliary Relay Output 4	5A AC250V voltage-free output
Auxiliary Relay Output 5	5A AC250V voltage-free output
Overall Dimensions	130mm x 112mm x 39mm
Panel Cutout	110mm x 90mm
CT Secondary Current	5A (rated)
Working Condition	Temperature: (-25~70)°C; Humidity: (20~93)%RH
Storage Condition	Temperature: (-25~70)°C
Protection Level	IP55 Gasket
Insulation Intensity	Apply AC2.2kV voltage between high voltage terminal and low voltage terminal; The leakage current is not more than 3mA within 1min.
Weight	0.26kg

## 4 OPERATION

### 4.1 PUSHBUTTONS

	Stop/ Reset	<p>Stop running generator in Auto/Manual mode;  In case of alarm condition, pressing the button will reset alarm;  In stop mode, pressing and holding the button for 3 seconds will test indicator lights (lamp test);  During stopping process, press this button again to stop generator immediately.</p>
	Start	Start genset in Manual/Test mode.
	Manual	Pressing this key will set the module into manual mode. Pressing  and  (or  ) simultaneously can adjust LCD contrast.
	Auto	Pressing this key will set the module into auto mode.
	Set/Confirm	Pressing this key will enter into Main Menu; In setting parameter status, press this key will shift cursor or confirm setting value.
	Up/Increase	Scrolls the screen up; Shift the cursor up or increase the set value in parameter setting menu.
	Down/Decrease	Scrolls the screen down; Shift the cursor down or decrease the set value in parameter setting menu.

## 4.2 INDICATOR LIGHT

### HGM410 Panel Indicators

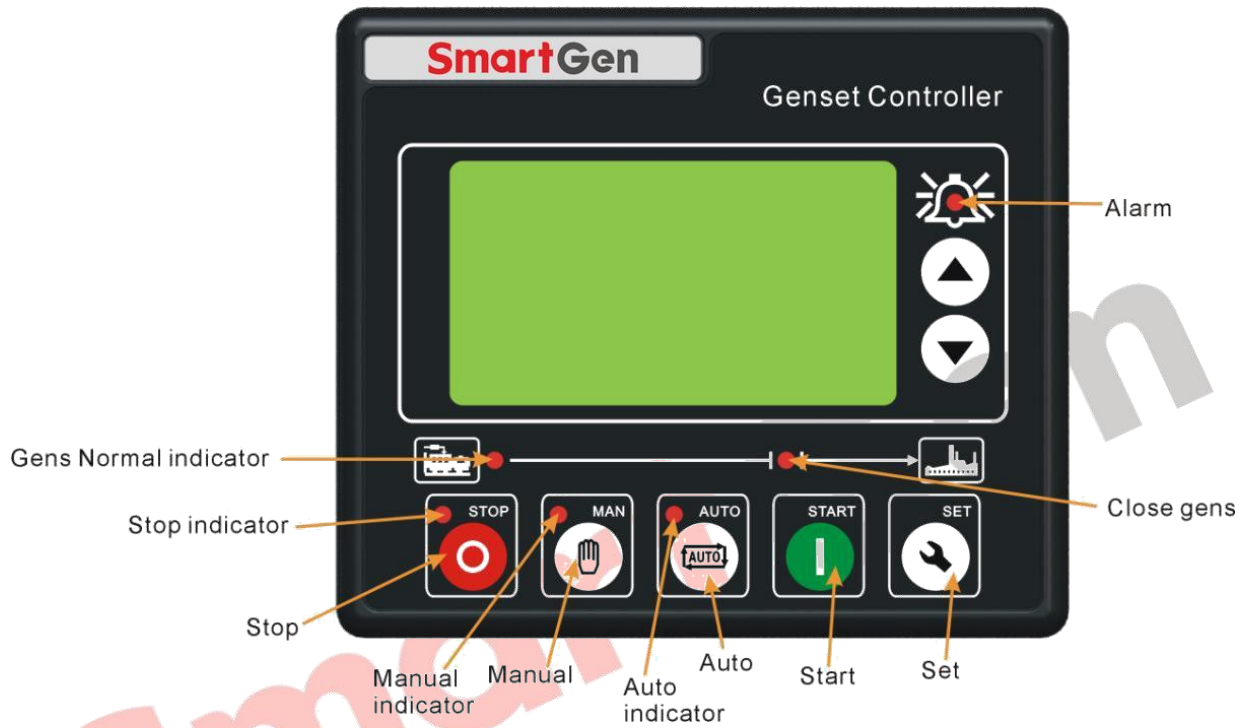

### HGM420 Panel Indicators



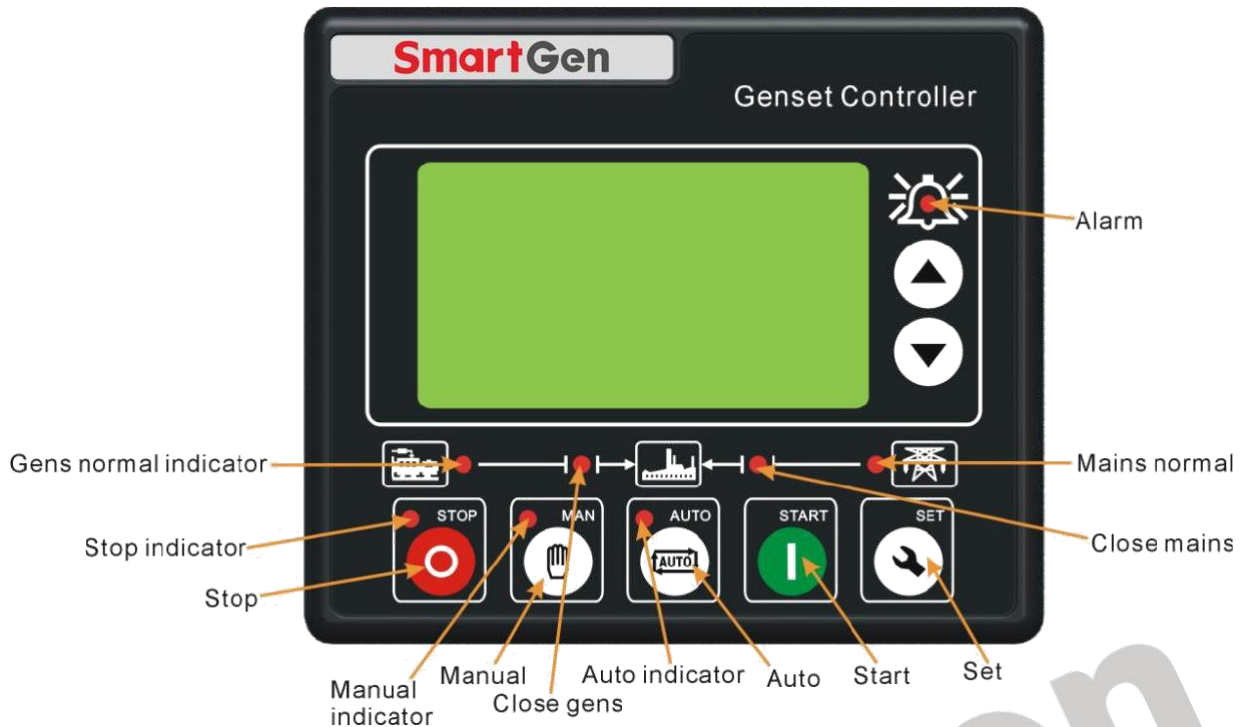

### 4.3 AUTOMATIC START/STOP OPERATION

Auto mode is selected by pressing the  button; a LED besides the button will illuminate to confirm the operation.

#### Auto Start Sequence,

- 1) **HGM420:** when mains is abnormal (over/under voltage, loss of phase), enter into “Mains Abnormal Delay” and LCD displays count down time. “Start Delay” timer is initiated after the delay has expired.
- 2) **HGM410:** When “Remote Start” is active, “Start Delay” timer is initiated;
- 3) “Start Delay” countdown will be displayed on LCD;
- 4) When start delay is over, preheat relay energizes (if configured), “preheat delay XXs” information will be displayed on LCD;
- 5) After the above delay, the Fuel Relay is energized, and then one second later, the Start Relay is engaged. The engine is cranked for a pre-set time. If the engine fails to fire during this cranking attempt then the fuel relay and start relay are disengaged for the pre-set rest period; “crank rest time” begins and wait for the next crank attempt.
- 6) Should this start sequence continue beyond the set number of attempts, the start sequence will be terminated, the fourth line of LCD display will be highlighted with



black and Fail to Start fault will be displayed.

- 7) In case of successful crank attempt, the “Safety On” timer is activated, allowing Low Oil Pressure, High Temperature, Under speed, Charge Alternator Failure and Auxiliary inputs (configured) to stabilise without triggering the fault. As soon as this delay is over, “start idle” delay is initiated (if configured).
- 8) During “start idle” delay, under speed, under frequency, under voltage alarms are inhibited. When this delay is over, “warming up” delay is initiated (if configured).
- 9) After the “warming up” delay, if generator status is normal, its indicator will be illuminated. If generator voltage and frequency have reached on-load requirements, then the generator close relay will be energized; genset will take load; generator power indicator will illuminate and generator will enter into Normal Running status. If voltage or frequency is abnormal, the controller will initiate shutdown alarm (alarm information will be displayed on LCD).



#### **Auto Stop Sequence,**

- 1) **HGM420:** During normal running process, if mains normal, enters into “Mains Normal Delay”. When mains indicator illuminates, “Stop Delay” is initiated.
- 2) **HGM410:** When the “Remote Start” signal is removed, the Stop Delay is initiated.
- 3) Once this “stop delay” has expired, the Generator Breaker will open and the “Cooling Delay” is then initiated. After “Transfer Delay”, the mains close relay will be energized; mains will take load; generator power indicator will extinguish while mains power indicator will illuminate.
- 4) During “Stop Idle” Delay (if configured), idle relay is energized.
- 5) “ETS Solenoid Hold” begins, ETS relay is energized while fuel relay is de-energized.
- 6) “Fail to Stop Delay” begins, complete stop is detected automatically.
- 7) Generator is placed into its standby mode after its complete stop. Otherwise, fail to stop alarm is initiated and the corresponding alarm information is displayed on LCD.

#### **4.4 MANUAL START/STOP OPERATION**

- 1) **HGM420:** Manual mode is selected by pressing the  button; a LED besides the button will illuminate to confirm the operation;  key, select “Mode Select”, then choose “**Test Mode**”. Under the two modes,  button to start the genset, it can automatically judge crank success and accelerate to high speed running. If high temperature, low oil pressure, over speed and abnormal voltage occur during genset

running, controller can effectively protect genset to stop (detail procedures please refer to No.4~9 of Auto start sequence). Under **Manual** , if mains normal, load breaker won't transfer; if mains abnormal, load breaker will transfer to generator. Under **Test Mode**, after genset high speed normal running, no matter mains normal or not, load will be transferred to generator.

- 2) **HGM410**: Manual mode is selected by pressing the  button; a LED besides the button will illuminate to confirm the operation; Then press  button to start the generator, it can automatically judge crank success and accelerate to high speed running. If high temperature, low oil pressure, over speed and abnormal voltage occur during genset running, controller can effectively protect genset to stop (detail procedures please refer to No.4~9 of Auto start sequence). After genset high speed normal running, controller will send Gen Closed signal.
- 3) Manual stop: pressing  key can stop the running genset. (detail procedures please refer to No.3~7 of Auto stop sequence)

## 5 PROTECTION

### 5.1 WARNINGS

Warnings are not shutdown alarms and do not affect the operation of the gen-set. Warning alarms does not lead to shutdown. The alarm information will be displayed on LCD.

Warning alarms types are as follows:

No.	Items	Description
1	High Temperature	When the controller detects that engine temperature has exceeded the pre-set value while shutdown is prohibited, or detects that the Aux. input high temperature while shutdown is prohibited, it will initiate a warning alarm and the corresponding alarm information will be displayed on LCD.
2	Low Pressure Oil	When the controller detects that the oil pressure has fallen below the pre-set value while shutdown is prohibited, or detects that the Aux. input low oil pressure while shutdown is prohibited, it will initiate a warning alarm and the corresponding alarm information will be displayed on LCD.



3	Gen Over Current	When the controller detects that the genset current has exceeded the pre-set value and the over current delay has expired, it will initiate a warning alarm and the corresponding alarm information will be displayed on LCD.
4	Fail To Stop	After “fail to stop” delay/ ETS delay has expired, if gen-set does not stop completely, it will initiate a warning alarm and the corresponding alarm information will be displayed on LCD.
5	Low Fuel Level	When the controller detects that the fuel level has fallen below the pre-set value while shutdown is prohibited, or detects that the Aux. input low fuel level while shutdown is prohibited, it will initiate a warning alarm and the corresponding alarm information will be displayed on LCD.
6	Charge Alt Failure	When the controller detects that charger voltage has fallen below the pre-set value, it will initiate a warning alarm and the corresponding alarm information will be displayed on LCD.
7	Battery Under Volt	When the controller detects that battery voltage has fallen below the pre-set value, it will initiate a warning alarm and the corresponding alarm information will be displayed on LCD.
8	Battery Over Volt	When the controller detects that battery voltage has exceeded the pre-set value, it will initiate a warning alarm and the corresponding alarm information will be displayed on LCD.
9	Auxiliary Input	When the controller detects that the auxiliary input warning signals, it will initiate a warning alarm and the corresponding alarm information will be displayed on LCD.
10	Loss Of Speed Signal	When the controller detects that the engine speed is 0 and the delay is 0, it will initiate a warning alarm and the corresponding alarm information will be displayed on LCD.
11	Low Coolant Level	When the controller detects the low coolant level input is active, it will initiate a warning alarm and the corresponding alarm information will be displayed on LCD.
12	Temp. Sensor Open	When the controller detects that the temperature sensor is open circuit and the action select “Warn”, it will initiate a warning alarm and the corresponding alarm information will be displayed on LCD.
13	Oil Pressure Sensor Open	When the controller detects that the oil pressure sensor is open circuit and the action select “Warn”, it will initiate a warning alarm and the corresponding alarm information will be displayed on LCD.



14	Level Sensor Open	When the controller detects that the level sensor is open circuit and the action select “Warn”, it will initiate a warning alarm and the corresponding alarm information will be displayed on LCD.
15	Temp. Sensor 2 Open	If the config. sensor set as temperature sensor, When the controller detects that the temperature sensor is open circuit and the action select “Warn”, it will initiate a warning alarm and the corresponding alarm information will be displayed on LCD.
16	Oil Pressure Sensor 2 Open	If the config. sensor set as oil pressure sensor, When the controller detects that the oil pressure sensor is open circuit and the action select “Warn”, it will initiate a warning alarm and the corresponding alarm information will be displayed on LCD.
17	Level Sensor 2 Open	If the config. sensor set as level sensor, When the controller detects that the level sensor is open circuit and the action select “Warn”, it will initiate a warning alarm and the corresponding alarm information will be displayed on LCD.
18	High Temperature 2	When the controller detects that config. sensor temperature (sensor type: temperature sensor) has exceeded the pre-set value while shutdown is prohibited, it will initiate a warning alarm and the corresponding alarm information will be displayed on LCD.
19	Low Oil Pressure 2	When the controller detects that config. sensor oil pressure (sensor type: oil pressure sensor) has fallen below the pre-set value while shutdown is prohibited, it will initiate a warning alarm and the corresponding alarm information will be displayed on LCD.
20	Low Fuel Level 2	When the controller detects that config. sensor fuel level (sensor type: level sensor) has fallen below the pre-set value while shutdown is prohibited, it will initiate a warning alarm and the corresponding alarm information will be displayed on LCD.
21	Maintenance Due	When genset running time has exceeded the user setting maintenance time and the action select “Warn”, it will initiate a warning alarm and the corresponding alarm information will be displayed on LCD. The maintenance alarm will reset if the action select “Inactive”.



## 5.2 SHUTDOWN ALARM

When controller detects shutdown alarm, it will send signal to open breaker and shuts down generator. The alarm information will be displayed on LCD.

Shutdown alarms as following:

No	Items	Description
1	Emergency Shutdown	When the controller detects that the emergency shutdown signal, it will initiate a shutdown alarm and the corresponding alarm information will be displayed on LCD.
2	High Temperature	When controller detects that the water/cylinder temperature has exceeded the pre-set value, it will initiate a shutdown alarm and the corresponding alarm information will be displayed on LCD.
3	Low Oil Pressure	When the controller detects that the oil pressure has fallen below the pre-set value, it will initiate a shutdown alarm and the corresponding alarm information will be displayed on LCD.
4	Over Speed	When the controller detects that the generator speed has exceeded the pre-set value, it will initiate a shutdown alarm and the corresponding alarm information will be displayed on



No	Items	Description
		LCD.
5	Under Speed	When the controller detects that the generator speed has fallen below the pre-set value, it will initiate a shutdown alarm and the corresponding alarm information will be displayed on LCD.
6	Loss Of Speed Signal	When the controller detects that the engine speed is 0 and the delay is <i>NOT</i> 0, it will initiate a shutdown alarm and the corresponding alarm information will be displayed on LCD.
7	Gen Over Voltage	When the controller detects that the genset voltage has exceeded the pre-set value, it will initiate a shutdown alarm and the corresponding alarm information will be displayed on LCD.
8	Gen Under Voltage	When the controller detects that the genset voltage has fallen below the pre-set value, it will initiate a shutdown alarm and the corresponding alarm information will be displayed on LCD.
9	Gen Over Current	When the controller detects that the genset current has exceeded the pre-set value and delay is not 0, it will initiate a shutdown alarm and the corresponding alarm information will be displayed on LCD.
10	Fail To Start	If the engine does not fire after the pre-set number of attempts, it will initiate a shutdown alarm and the corresponding alarm information will be displayed on LCD.
11	Gen Over Frequency	When the controller detects that the genset frequency has exceeded the pre-set value, it will initiate a shutdown alarm and the corresponding alarm information will be displayed on LCD.
12	Gen Under Frequency	When the controller detects that the genset frequency has fallen below the pre-set value, it will initiate a shutdown alarm and the corresponding alarm information will be displayed on LCD.
13	No Gens Frequency	When the controller detects that the genset frequency is 0, it will initiate a shutdown alarm and the corresponding alarm information will be displayed on LCD.
14	Low Fuel Level	When the controller detects that the fuel level has fallen below the pre-set value or detects that the low fuel level input is active, it will initiate a shutdown alarm and the corresponding alarm information will be displayed on LCD.
15	Low Coolant Level	When the controller detects the low coolant level input is active, it will initiate a shutdown alarm and the corresponding alarm information will be displayed on LCD.
16	Temp. Sensor	When the controller detects that the temperature sensor is



No	Items	Description
	Open	open circuit and the action select “Shutdown”, it will initiate a shutdown alarm and the corresponding alarm information will be displayed on LCD.
17	Oil Pressure Sensor Open	When the controller detects that the oil pressure sensor is open circuit and the action select “Shutdown”, it will initiate a shutdown alarm and the corresponding alarm information will be displayed on LCD.
18	Level Sensor Open	When the controller detects that the level sensor is open circuit and the action select “Shutdown”, it will initiate a shutdown alarm and the corresponding alarm information will be displayed on LCD.
19	Temp. Sensor 2 Open	If the config. sensor set as temperature sensor, When the controller detects that the temperature sensor is open circuit and the action select “Shutdown”, it will initiate a shutdown alarm and the corresponding alarm information will be displayed on LCD.
20	Oil Pressure Sensor 2 Open	If the config. sensor set as oil pressure sensor, When the controller detects that the oil pressure sensor is open circuit and the action select “Shutdown”, it will initiate a shutdown alarm and the corresponding alarm information will be displayed on LCD.
21	Level Sensor 2 Open	If the config. sensor set as level sensor, When the controller detects that the level sensor is open circuit and the action select “Shutdown”, it will initiate a shutdown alarm and the corresponding alarm information will be displayed on LCD.
22	High Temperature 2	When the controller detects that config. sensor temperature (sensor type: temperature sensor) has exceeded the pre-set value, it will initiate a shutdown alarm and the corresponding alarm information will be displayed on LCD.
23	Low Oil Pressure 2	When the controller detects that config. sensor oil pressure (sensor type: oil pressure sensor) has fallen below the pre-set value, it will initiate a shutdown alarm and the corresponding alarm information will be displayed on LCD.
24	Low Fuel Level 2	When the controller detects that config. sensor fuel level (sensor type: level sensor) has fallen below the pre-set value, it will initiate a shutdown alarm and the corresponding alarm information will be displayed on LCD.
25	Maintenance Due	When genset running time has exceeded the user setting maintenance time and the action select “Shutdown”, it will initiate a shutdown alarm and the corresponding alarm information will be displayed on LCD. The maintenance alarm will reset if the action select “Inactive”.



## 6 CONNECTIONS

Compared with **HGM420**, **HGM410** has no Mains AC Voltage input terminals. The rear panel of **HGM410** and **HGM420** is as below.

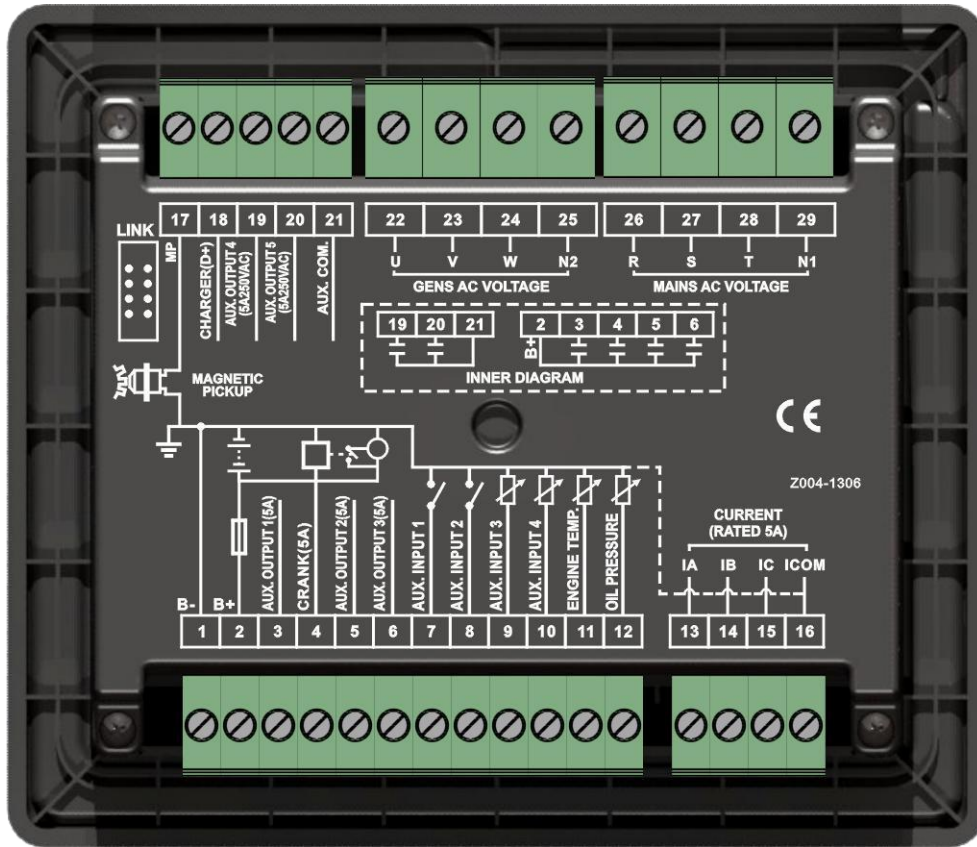

Description of terminal connections:

Pin	Function	Cable Size	Description
1	B-	1.5mm <sup>2</sup>	Connected with negative of starter battery.
2	B+	1.5mm <sup>2</sup>	DC power supply. Connected with positive of starter battery. If wire length is over 30m, better to double wires in parallel. Max. 20A fuse is recommended.
3	Aux. Output 1	1.0mm <sup>2</sup>	B+ is supplied by 2 point, rated 5A.
4	Crank	1.0mm <sup>2</sup>	Crank Relay Output; B+ is supplied by 2 point, rated 5A. Connect to starter coil.
5	Aux. Output 2	1.0mm <sup>2</sup>	B+ is supplied by 2 point, rated 5A.
6	Aux. Output 3	1.0mm <sup>2</sup>	B+ is supplied by 2 point, rated 5A.
7	Aux. Input 1	1.0mm <sup>2</sup>	Ground connected is active (B-)
8	Aux. Input 2	1.0mm <sup>2</sup>	Ground connected is active (B-)
9	Aux. Input 3	1.0mm <sup>2</sup>	Ground connected is active (B-); Can be used as Level Sensor.
10	Aux. Input 4	1.0mm <sup>2</sup>	Ground connected is

See [Table 3](#)



Pin	Function	Cable Size	Description
			active (B-); Can be used as Config. Sensor.
11	Engine Temperature Sensor	1.0mm <sup>2</sup>	Connect to temperature/cylinder resistance sensor.
12	Oil Press Sensor	1.0mm <sup>2</sup>	Connect to oil pressure resistance sensor.
13	Current IA	1.5mm <sup>2</sup>	Outside connected to secondary coil of current transformer(rated 5A)
14	Current IB	1.5mm <sup>2</sup>	Outside connected to secondary coil of current transformer(rated 5A)
15	Current IC	1.5mm <sup>2</sup>	Outside connected to secondary coil of current transformer(rated 5A)
16	Current COM	1.5mm <sup>2</sup>	See INSTALLATION in this manual.
17	Magnetic Pickup	0.5mm <sup>2</sup>	Connect to speed sensor; Shielded wire is recommended. The other end of speed sensor connects to B-.
18	Charger D+	1.0mm <sup>2</sup>	Connect to charging starter's D+ terminal. If there is no this terminal, then be hang up.
19	Aux. Output 4	1.0mm <sup>2</sup>	The combination of terminal 19 and 21 is relay normally open contact; rated 5A; Voltage free.
20	Aux. Output 5	1.0mm <sup>2</sup>	The combination of terminal 20 and 21 is relay normally open contact; rated 5A; Voltage free.
21	Aux. Output COM	1.5mm <sup>2</sup>	Common terminal of auxiliary output 4 and 5.
22	Gen AC Voltage U	1.0mm <sup>2</sup>	Connected to U-phase of generator (2A fuse is recommended)
23	Gen AC Voltage V	1.0mm <sup>2</sup>	Connected to V-phase of generator (2A fuse is recommended)
24	Gen AC Voltage W	1.0mm <sup>2</sup>	Connected to W-phase of generator (2A fuse is recommended)
25	Gen AC Voltage N2	1.0mm <sup>2</sup>	Connected to N-wire of generator.
26	Mains AC Voltage R	1.0mm <sup>2</sup>	Connected to R-phase of mains (2A fuse is recommended) ( <b>HGM410</b> without)
27	Mains AC Voltage S	1.0mm <sup>2</sup>	Connected to S-phase of mains (2A fuse is recommended) ( <b>HGM410</b> without)
28	Mains AC Voltage T	1.0mm <sup>2</sup>	Connected to T-phase of mains (2A fuse

Pin	Function	Cable Size	Description
			is recommended) ( <b>HGM410</b> without)
29	Mains AC Voltage N1	1.0mm <sup>2</sup>	Connected to N-wire of mains ( <b>HGM410</b> without)

**▲ NOTE:** LINK interface is parameters programmable interface that can be programmed by PC using an SG72 adapter. If there is need to remote control the genset, please use the SG485 module produced by our company.

SmartGen

## 7 DEFINITION AND RANGE OF PARAMETERS



## 7.1 PARAMETER CONTENTS AND RANGE (TABLE 1)

No	Items	Range	Default	Description
1	Mains Delay Normal	(0-3600)s	10	The time from mains abnormal to normal or from normal to abnormal; suitable for ATS (automatic transfer switch).
2	Mains Delay Abnormal	(0-3600)s	5	
3	Mains Voltage Under	(30-620)V	184	When mains voltage has fallen below the set value, Mains Under Voltage is active. When set the value as 30V, the controller does not detect under voltage signal. Back lash: 10V
4	Mains Voltage Over	(30-620)V	276	When mains voltage has exceeded the set value, Mains Over Voltage is active. When set the value as 620V, the controller does not detect over voltage signal. Back lash: 10V
5	Transfer Delay Rest	(0-99.9)s	1.0	Interval time from mains switch off to generator switch on; or from generator switch off to mains switch on.
6	Start Delay	(0-3600)s	1	Time from mains abnormal or remote start signal is active to start genset.
7	Stop Delay	(0-3600)s	1	Time from mains normal or remote start signal is deactivated to genset stop.
8	Start Attempts	(1-10)times	3	Maximum crank times of crank attempts. When reach this number, controller will send start failure signal.
9	Preheat Time	(0-300)s	0	Power-on time of heater plug before starter is powered up.
10	Cranking Time	(3-60)s	8	Power-on time of starter
11	Crank Rest Time	(3-60)s	10	The waiting time before second power up when engine start fail.



No	Items	Range	Default	Description
12	Safety On Delay	(1-60)s	10	Alarms for low oil pressure, high temperature, under speed, under frequency/voltage, charge alt failure are inactive.
13	Start Idle Time	(0-3600)s	0	Idle running time of genset when starting.
14	Warming Up Time	(0-3600)s	10	Warming time between genset switch on and high speed running.
15	Cooling Time	(3-3600)s	10	Radiating time before genset stop, after it unloads.
16	Stop Idle	(0-3600)s	0	Idle running time when genset stop.
17	ETS Solenoid Hold	(0-120)s	20	Stop electromagnet's power on time when genset is stopping.
18	Fail to Stop Delay	(0-120)s	0	Time between ending of genset idle delay and stopped when "ETS time" is set as 0; Time between ending of ETS hold delay and stopped when "ETS time" is not 0.
19	Breaker Close Time	(0-10)s	5.0	Pulse width of mains/generator switch on. When it is 0, means output constantly.
20	Flywheel Teeth	(10-300)	118	Tooth number of the engine, for judging of starter crank disconnect conditions and inspecting of engine speed. See the installation instructions.
21	Gen Abnormal Delay	(0-20.0)s	10.0	The alarm delay of generator over voltage and under voltage.
22	Gen Over Voltage	(30-620)V	264	When generator voltage has exceeded the set value and the "Gen abnormal delay" has expired, Gen Over Voltage is active. When set the value as 620V, the controller does not detect over voltage signal.



No	Items	Range	Default	Description
23	Generator Under Voltage	(30-620)V	196	When generator voltage has fallen below the set value and the “Gen abnormal delay” has expired, Gen Under Voltage is active. When set the value as 30V, the controller does not detect under voltage signal.
24	Under Speed	(0-6000)RPM	1200	When engine speed has fallen below the set value for 10s, Under Speed is active. It will initiate a shutdown alarm signal.
25	Over Speed	(0-6000)RPM	1710	When engine speed has exceeded the set value for 2s, Over Speed is active. It will initiate a shutdown alarm signal.
26	Under Frequency	(0-75.0)Hz	45.0	When generator frequency has fallen below the set value but Not equal to 0 for 10s, Under Frequency is active. It will initiate a shutdown alarm signal.
27	Over Frequency	(0-75.0)Hz	57.0	When generator frequency has exceeded the set value for 2s, Over Frequency is active. It will initiate a shutdown alarm signal.
28	High Temperature	(80-140)°C	98	When the temperature value of the external temperature sensor exceeds the set value, “High Temperature” timer is initiated. Detecting only after safety on delay has expired. If the set value is 140, high temperature signal will not be sent (this only concerns external temperature sensor, not high temperature signal via config. input port).





No	Items	Range	Default	Description
29	Low Oil Pressure	(0-400)kPa	103	When the external pressure sensor value falls below this set value, "Low Oil Pressure" timer is initiated. Detecting only after safety on delay has expired. If the set value is 0, low oil pressure signal will not be sent (this only concerns pressure sensor and does not concern low oil pressure warning signal via configurable input port)
30	Low Fuel Level	(0-100)%	10	When the liquid level of the external sensor falls below the set value, "Low Fuel Level" timer is initiated. (this only concerns fuel level sensor and does not concern low fuel level warning signal via configurable input port)
31	Config. Sensor	(80-140)°C (0-400)kPa (0-100)%	98 103 10	Each value correspond to above 28 (Temperature sensor), 29 (Oil pressure sensor) and 30 (Level sensor), respectively.
32	Loss of Speed Signal	(0-20.0)s	5.0	If the set value is 0, only warning and not to shutdown the generator.
33	Charge Alt Failure	(0-30)V	6.0	During generator is normal running, when alternator D+(WL) voltage has fallen below the set value and remains for 5s, It will initiate a shutdown alarm signal.
34	Battery Voltage Over	(12-40)V	33.0	When battery voltage has exceeds the set value and remains for 20s, It will initiate a warning alarm signal. Only warning and not to shutdown the generator.
35	Battery Voltage Under	(4-30)V	8.0	When battery voltage has fallen below the set value and remains for 20s, It will initiate a warning alarm signal. Only warning and not to shutdown the generator.





No	Items	Range	Default	Description
36	Current Trans.	(5-6000)/5	500	The ratio of external CT
37	Full Load Current Rating	(5-6000)A	500	Generator's rated current, used for load over current calculating.
38	Over Current Percentage	(50-130)%	120	When the load current has exceeded the set value, "over current" delay is initiated.
39	Over Current Delay	(0-3600)s	1296	When load current has exceeded the set value and the "over current" delay has expired, over current alarm is initiated. When the set value is 0, only warning and not to shutdown the generator.
40	Fuel Pump On	(0-100)%	25	When fuel level has fallen below the set value for 10s, "Fuel Pump On" alarm is initiated.
41	Fuel Pump Off	(0-100)%	80	When fuel level has exceeded the set value for 10s, "Fuel Pump Off" alarm is initiated.
42	Aux. Output 1	(0-17)	14	Factory default: Fuel Relay Output
43	Aux. Output 2	(0-17)	2	Factory default: Energized To Stop
44	Aux. Output 3	(0-17)	3	Factory default: Idle Control
45	Aux. Output 4	(0-17)	5	Factory default: Close Generator
46	Aux. Output 5	(0-17)	6	Factory default: Mains Closed
47	Aux. Input 1	(0-15)	1	Factory default: High Temperature Input
48	Aux. Input 1 Active	(0-1)	0	Factory default: Close to active
49	Aux. Input 1 Delay	(0-20.0)s	2.0	
50	Aux. Input 2	(0-15)	2	Factory default: Low Oil Pressure Warning Input
51	Aux. Input 2 Active	(0-1)	0	Factory default: Close to active
52	Aux. Input 2 Delay	(0-20.0)s	2.0	
53	Aux. Input 3	(0-15)	10	Factory default: Remote Start
54	Aux. Input 3 Active	(0-1)	0	Factory default: Close to active



No	Items	Range	Default	Description
55	Aux. Input 3 Delay	(0-20.0)s	2.0	
56	Aux. Input 4	(0-15)	11	Factory default: Fuel Level Warn
57	Aux. Input 4 Active	(0-1)	0	Factory default: Close to active
58	Aux. Input 4 Delay	(0-20.0)s	2.0	
59	Power On Mode	(0-2)	0	0: Stop Mode 1: Manual Mode 2: Auto Mode
60	Module Address	(1-254)	1	Communication address of controller.
61	Passwords	(0-9999)	1234	
62	Crank Disconnect	(0-5)	2	There are 3 conditions of disconnecting starter with engine: Generator Frequency, Magnetic Pickup, Oil Pressure. Each condition can be used alone and simultaneously to separating the start motor and genset as soon as possible. See <a href="#">Table 5</a>
63	Disconnect Magnetic Pickup	(0-3000)RPM	360	When engine speed higher than the set value, starter will be disconnected.
64	Disconnect Generator Freq	(10.0-30.0)Hz	14.0	When generator frequency higher than the set value, starter will be disconnected.
65	Disconnect Oil Pressure	(0-400)kPa	200	When generator oil pressure higher than the set value, starter will be disconnected.
66	High Temperature Inhibit	(0-1)	0	Factory default: when high temperature occurs, shutdown alarm is initiated. <b>Note 1</b>
67	Low Oil Pressure Inhibit	(0-1)	0	Factory default: when low oil pressure occurs, shutdown alarm is initiated. <b>Note 2</b>
68	Low Fuel Level Inhibit	(0-1)	1	Factory default: when low fuel level occurs, shutdown alarm is initiated. <b>Note 2</b>



No	Items	Range	Default	Description
69	Config. Sensor Inhibit	(0-1)	1	Factory default: when config. sensor value higher/lower than the set value (particular case depends on the sensor type), shutdown alarm is initiated. <b>Note 2</b>
70	AC System	(0-3)	0	0: 3P4W; 1: 2P3W 2: 1P2W; 3: 3P3W <b>Note 3</b>
71	Temp. Sensor Curve	(0-9)	08	SGX
72	Pressure Sensor Curve	(0-9)	08	SGX
73	Multiplex Input 1	(0-1)	0	0: Aux. Input 3 1: Level Sensor <b>Note 4</b>
74	Level Sensor Curve	(0-5)	3	SGD
75	Multiplex Input 2	(0-3)	0	0: Aux. Input 4 1: Temperature Sensor 2: Oil Pressure Sensor 3: Level Sensor <b>Note 4</b>
76	Config. Sensor Curve	(0-9) (0-9) (0-5)	8 8 3	SGX SGX SGD
77	Poles	(2-32)	4	
78	Temperature Sensor Open	(0-2)	1	0: Indication (temperature sensor will show “+++”); 1:Warn; 2:Shutdown
79	Oil Pressure Sensor Open	(0-2)	1	0: Indication (oil pressure sensor will show “+++”); 1:Warn; 2:Shutdown
80	Fuel Level Sensor Open	(0-2)	1	0: Indication (fuel level sensor will show “+++”); 1:Warn; 2:Shutdown
81	Config. Sensor Open	(0-2)	1	0: Indication (LCD display will show “+++”); 1:Warn; 2:Shutdown
82	Cooling Blower On	(0-140)°C	60	It controls the cooling blower to open or close if the output port is configured as Cooling Blower.
83	Cooling Blower Off	(0-140)°C	40	



No	Items	Range	Default	Description
84	Low Fuel Level Warn	(0-100)%	20	When the liquid level of the external sensor falls below the set value, "Low Fuel Level" timer is initiated. (this only concerns fuel level sensor and does not concern low fuel level warning signal via configurable input port)
85	Maintenance Enable	(0-1)	0	0: Disable 1: Enable
86	Maintenance Due	(0-5000)h	30	Use for setting the maintenance interval.
87	Maintenance Due Action	(0-1)	0	0: Warn 1: Shutdown
88	Custom Sensor Curve	(0-3)	0	It can be customized as Temp. sensor, OP sensor, Fuel level sensor and Config. sensor curve.

▲ **Note 1**, if "high temperature inhibit" is configured, or set auxiliary input as "inhibit high temperature stop" and this input is active, when temperature is higher than the preset value, or high temperature alarm input is active, controller will send warning signal only and not stop the unit.

▲ **Note 2**, if "low oil pressure inhibit" is configured, or set auxiliary input as "inhibit low oil pressure stop" and this input is active, when oil pressure is lower than the preset value, or low oil pressure alarm input is active, controller will send warning signal only and not stop the unit.

▲ **Note 3**, if "3P3W" is selected, maximum shutdown threshold of "Mains Over Voltage" and "Gens Over Voltage" can be set as 620V; when select others, maximum shutdown threshold can be set as 360V.

▲ **Note 4**, Multiplex Input can be set as "auxiliary input" or "level sensor"; if one of them is set successfully, then the corresponding items are active. For instance, if set "Multiplex Input 3" as "Auxiliary Input", the related configuration items of auxiliary input 3 are active; if set "Multiplex Input 3" as "Level Sensor", the related configuration items of level sensor are active;



## 7.2 PROGRAMMABLE OUTPUT 1-5 (TABLE 2)

No	Items	Description
0	Not Used	Output port is deactivated when “Not Used” is selected.
1	Common Alarm	Include all shutdown alarms and warning alarms. When there is warning alarm only, it is not self-lock; when a shutdown alarm occurs, it is self-lock until the alarm is reset.
2	Energized to Stop	Suitable for genset with electromagnet and will active after “stop idle delay”. It is deactivated when the “ETS Solenoid delay” expires.
3	Idle Control	Used for engine which has idles. Close before starting and open in warming up delay; Close during stop idle delay and open when stop is completed.
4	Preheat Control	Close before starting and open before power up;
5	Close Generator	When close time is 0, it's continuous output.
6	Mains Closed	When close time is 0, it's continuous output. <b>(HGM410 without)</b>
7	Open ATS	When close time is 0, it's disabled.
8	Raise Speed	Close when the generator enters into Warming Up delay (close time: warming up delay) while open when Aux.
9	Drop Speed	Close when the generator enters into Stop Idle delay/ Energized to Stop delay (close time: Stop Idle delay) while open when Aux.
10	Generator Run	Action when genset is normal running while deactivated when engine speed is lower than the “crank disconnect speed”.
11	Fuel Pump Control	Close when fuel level is lower than the “Fuel Pump On” value or when low fuel level warning input is active; Open when fuel level is higher than the “Fuel Pump Off” and low fuel level warning input is deactivated;
12	High Speed Control	Close when the generator enters into Warming Up delay while open after cooling delay.
13	In Auto Mode	The controller is in automatic mode.
14	Fuel Relay Output	To control fuel relay output.
15	Generator Excite	Output in start period. If there is no generator frequency during safety running, output for 2 seconds.
16	Air Cooler Output	Control air cooler to start\stop according to cooler temperature.
17	Reserved	



### 7.3 PROGRAMMABLE INPUT 1-4 TABLE (ACTIVE WHEN CONNECT GND (B-)) (TABLE 3)

No	Items	Description
0	Not Used	
1	High Temperature Input	If these signals are active after safety on delay, shutdown alarm will be immediately initiated.
2	Low Oil Pressure Warning Input	
3	Auxiliary Warning	Only warning and not stops if this input is active.
4	Emergency Stop Input	Shutdown alarm will be immediately initiated if this input is active.
5	High Temperature Stop Input	When the gen-set is running normally and this signal is activated, if there is a high temperature situation, the controller will first cool down the generator and then stop it; if the signal is deactivated and a high temperature situation occurs, the controller will shut down the gen-set without cooling down.
6	Generator Closed Input	
7	Mains Closed Input	<b>HGM410</b> without
8	Inhibit High Temperature Stop	When it is active, prohibit stopping when high temperature occurs. <b>Note 1</b>
9	Inhibit Low Oil Pressure Stop	When it is active, prohibit stopping when low oil pressure occurs. <b>Note 2</b>
10	Remote Start	<b>HGM420</b> without
11	Fuel Level Warn	
12	Coolant Level Warn	
13	Fuel Level Shutdown	
14	Coolant Level Shutdown	
15	Auto Start Inhibit	In Auto mode, if this input is active, whether mains is normal or not ( <b>HGM420</b> ) or a remote start signal occurs ( <b>HGM410</b> ), the controller will not give a start command to the generator. If generator is normal running, stop command won't be executed. When this input is deactivated, genset will automatically start or stop according to the mains status (normal or abnormal).
16	Reversed	
17	Reversed	
18	Panel Lock	When input is active, all keys expect the "Up\Down"





No	Items	Description
		buttons are inactive.
19	Manual/Auto Switch	When input is active, enter into auto mode automatically, panel buttons and local operation are inactive; When input is inactive, enter into manual mode automatically, remote operation is inhibited.
20	Reversed	
21	Reversed	
22	Reversed	
23	Reversed	
24	Reversed	
25	Reversed	
26	Reversed	
27	Reversed	
28	Reversed	
29	Reversed	
30	Reversed	
31	Reversed	

SmartGen

## 7.4 SENSOR SELECT (TABLE 4)

No		Content	Description
1	Temperature Sensor	0 Not used 1 User Defined Resistive Type 2 VDO 3 SGH(Huanghe sensor) 4 SGD(Dongkang sensor) 5 CURTIS 6 DATCON 7 VOLVO-EC 8 SGX 9 Reserved	Defined resistive range is (0~6000) $\Omega$ , default is SGX sensor.
2	Pressure Sensor	0 Not used 1 User Defined Resistive Type 2 VDO 10Bar 3 SGH(Huanghe sensor) 4 SGD(Dongkang sensor) 5 CURTIS 6 DATCON 7 VOLVO-EC 8 SGX 9 Reserved	Defined resistive range is (0~6000) $\Omega$ , default is SGX sensor.
3	Fuel Level Sensor	0 Not used 1 User Defined Resistive Type 2 SGH 3 SGD 4 Reserved 1 5 Reserved 2	Defined resistive range is (0~6000) $\Omega$ , default is SGD sensor.



## 7.5 CONDITIONS OF CRANK DISCONNECT (TABLE 5)

No	Content
0	Magnetic pickup
1	Generator Frequency
2	Magnetic pickup + Generator Frequency
3	Magnetic pickup + Oil pressure
4	Generator Frequency + Oil pressure
5	Generator Frequency + Magnetic pickup + Oil pressure

1. There are 3 conditions to make starter separate with engine; magnetic pickup, generator frequency can be used separately while oil pressure must be used together with magnetic pickup and generator frequency. The aim is to disconnect the starter motor as soon as possible.
2. Magnetic pickup is the magnetic equipment which be installed in starter for detecting flywheel teeth.
3. When set as magnetic pickup, must ensure that the number of flywheel teeth is as same as setting, otherwise, “over speed shutdown” or “under speed shutdown” may be caused.
4. If genset without magnetic pickup, please don't select corresponding items, otherwise, “start fail” or “loss speed signal” maybe caused.
5. If genset without oil pressure sensor, please don't select corresponding items.
6. If not select generator frequency in crank disconnect setting, controller will not collect and display the relative power quantity (can be used in water pump set); if not select magnetic pickup in crank disconnect setting, the engine speed displayed in controller is calculated by generator signal.

## 8 PARAMETERS SETTING

Start the controller, then  to enter into the parameters setting menu, see fig 1 below:

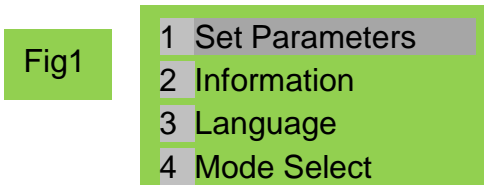

### ◆ Parameters Setting

When entering password interface, inputting “1234” can set part of the parameter items in [Table 1](#) while “0318” can set all the items. If there is need to set more parameters (e.g. voltage calibration; current calibration), please contact the factory.

### NOTES:

1. For **HGM410**, there are no items from 1 to 5 in [Table 1](#); there are no mains items in auxiliary output 1-5.
2. Please change the controller parameters when generator is in standby mode only (e. g. Crank disconnect conditions selection, auxiliary input, auxiliary output, various delay), otherwise, shutdown and other abnormal conditions may occurs.
3. Over voltage set value must be higher than under voltage set value, otherwise over voltage and under voltage condition may occur simultaneously.
4. Over speed set value must be higher than under speed set value, otherwise over speed and under speed condition may occursimultaneously.
5. Please set the generator frequency value as low as possible when cranking, in order to make the starter be separated quickly as soon as possible.
6. Auxiliary input 1~4 could not be set as same items; otherwise, there are abnormal functions. However, the auxiliary output 1~5 can be set as same items.
7. If need to shut down after cooling, please set any auxiliary input as “High Temperature Stop Input”, then connect this input port to GND.

### ◆ Information

LCD will display software version, issue date of the controller.



 **Note:** In this interface, press  will display the auxiliary inputs and outputs status.

### ◆ Language

Chinese, English, Spanish, Turkish and Russian interface can be selected.

### ◆ Mode Select

The controller can be set as Test Mode, Manual Mode, Auto Mode or Stop Mode.

 **Note:** Pressing  key at any time will quit the setting and return to the

previous setting menu.

## 9 SENSOR SETTING

- 1) When reselect sensors, the sensor curve will be transferred into the standard value. For example, if temperature sensor is SGH (120° C resistor type), its sensor curve is SGH (120° C resistor type); if select the SGD (120° C resistor type), the temperature sensor curve is SGD curve.
- 2) When there is difference between standard sensor curves and using sensor, user can adjust it in “curve type” .
- 3) When input the sensor curve, X value (resistor) must be input from small to large, otherwise, mistake occurs.
- 4) If select sensor type as “None” , sensor curve is not working and LCD does not display the sensor information.
- 5) If there is no oil pressure sensor, but there is low oil pressure alarm switch, user must set the oil pressure sensor as “None” , otherwise, maybe low oil pressure shutdown occurs.
- 6) The headmost or backmost values in the vertical coordinates can be set as same as below,

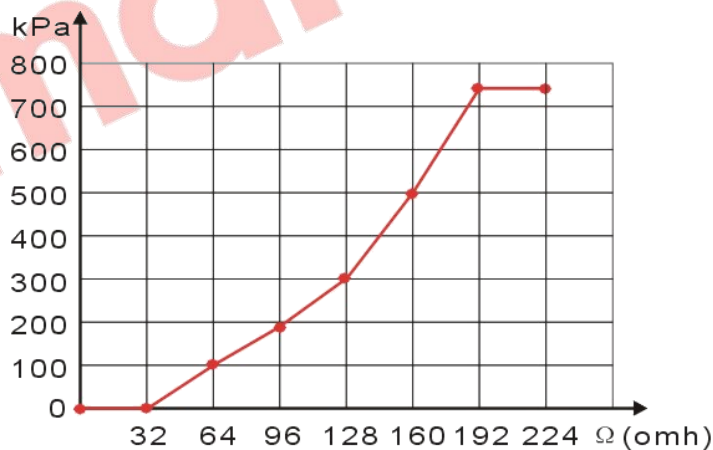

**Common unit conversion table**

	N/m <sup>2</sup> (pa)	kgf/cm <sup>2</sup>	bar	(p/in <sup>2</sup> .psi)
1Pa	1	1.02x10 <sup>-5</sup>	1x10 <sup>-5</sup>	1.45x10 <sup>-4</sup>
1kgf/cm <sup>2</sup>	9.8x10 <sup>4</sup>	1	0.98	14.2
1bar	1x10 <sup>5</sup>	1.02	1	14.5
1psi	6.89x10 <sup>3</sup>	7.03x10 <sup>-2</sup>	6.89x10 <sup>-2</sup>	1

## 10 COMMISSIONING

Please make sure the following checks are made before commissioning,

1. Ensure all the connections are correct and wires diameter is suitable.
2. Ensure that the controller DC power has fuse, controller's positive and negative connected to start battery are correct.
3. Take proper action to prevent engine to crank success (e. g. Remove the connection wire of fuel valve). If checking is OK, make the start battery power on; choose manual mode and controller will executive routine.
4. Set controller under manual mode, press "start" button, genset will start. After the cranking times as setting, controller will send signal of Start Failure; then press "stop" to reset controller.
5. Recover the action to prevent engine to crank success (e. g. Connect wire of fuel valve), press start button again, genset will start. If everything goes well, genset will normal running after idle running (if idle run be set). During this time, please watch for engine's running situations and AC generator's voltage and frequency. If abnormal, stop genset and check all wires connection according to this manual.
6. Select the **AUTO** mode from controller's panel, connect mains signal. After the mains normal delay, controller will transfer ATS (if fitted) into mains load. After cooling time, controller will stop genset and make it into "at rest" mode until there is mains abnormal situation.
7. When mains is abnormal again, genset will be started automatically and enter into normal running, then controller send signal to making generator switch on, and control the ATS transfer into generator load. If not like this, please check ATS' wires connection according to this manual.
8. If there is any other question, please contact Smartgen's service.

## 11 TYPICAL APPLICATION

**HGM410** Typical wiring diagram

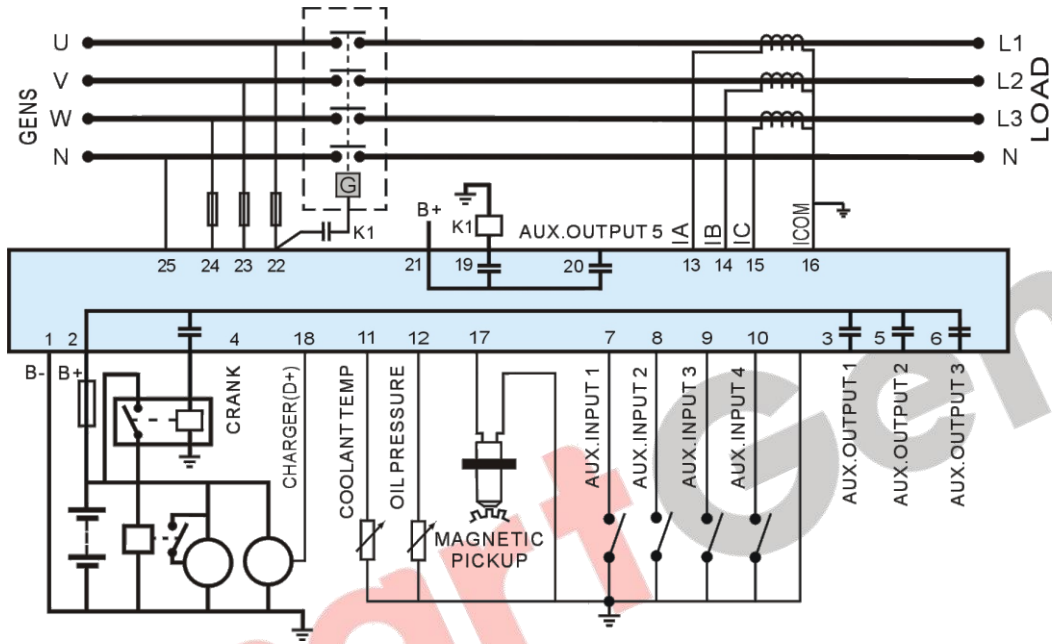

**Note:** Aux. Input 3 can be set as level sensor; Aux. Input 4 can be set as temperature sensor, oil pressure sensor or level sensor.

**HGM420** Typical wiring diagram

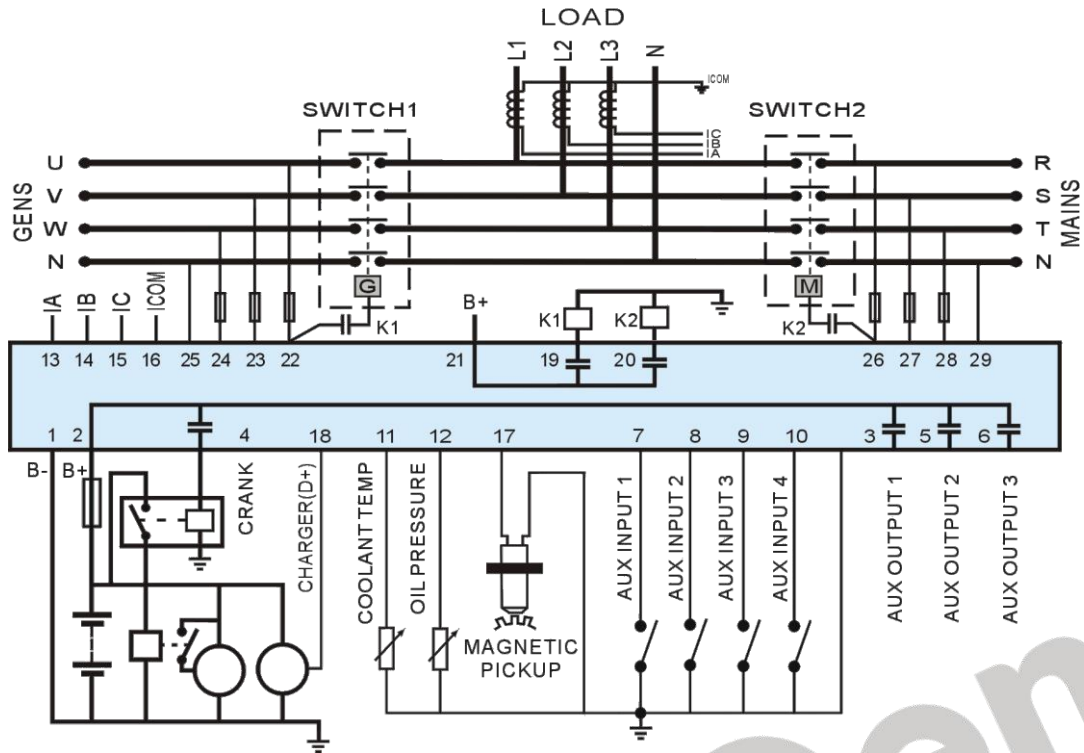

### Single Phase 2 Wire (HGM420)

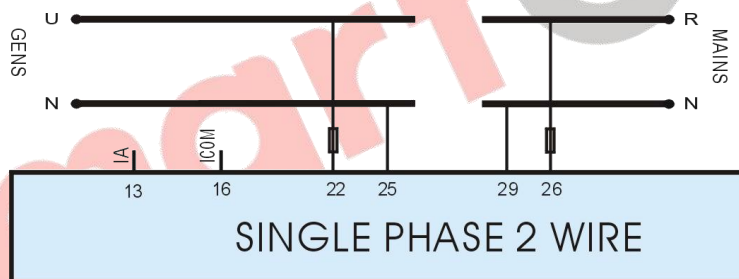

### 2 Phase 3 Wire (HGM420)

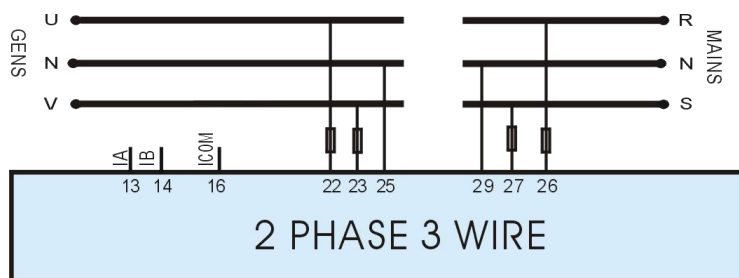

**⚠ CAUTION!** Expand relay with high capacity in start and fuel output is recommend.

**⚠ CAUTION!** Expand relay must be used in mains/gen closed outputs.



**CAUTION!** Let its normally closed contact series connect between fuel relay output port and electromagnetic valve when you connect emergency stop button on the controller. Emergency stop alarm can be displayed if you configure one input port as “Emergency Shutdown” (one end connect to normally open contact, the other end connect to ground).

## 12 INSTALLATION

### 12.1 FIXING CLIPS

Controller is panel built-in design; it is fixed by clips when installed.

- 1) Withdraw the fixing clip screw (turn anticlockwise) until it reaches proper position.
- 2) Pull the fixing clip backwards (towards the back of the module) ensuring two clips are inside their allotted slots.
- 3) Turn the fixing clip screws clockwise until they are fixed on the panel.



**Note:** Care should be taken not to over tighten the screws of fixing clips.



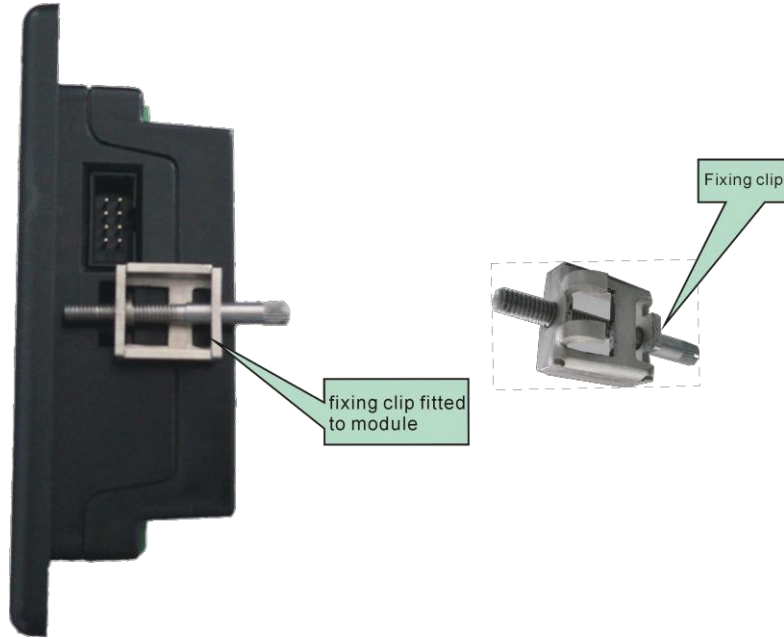

## 12.2 OVERALL DIMENSION AND PANEL CUTOUT

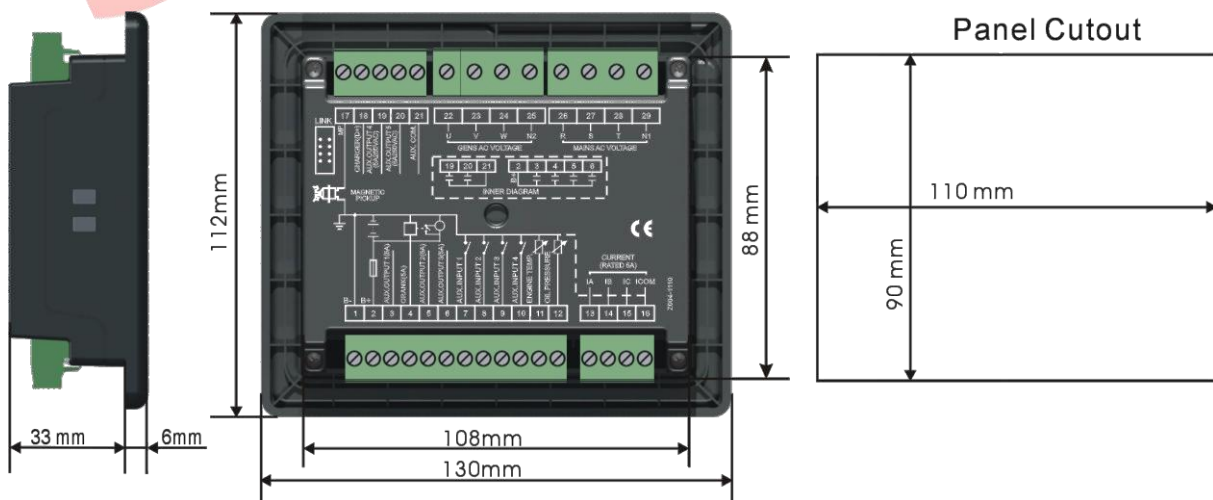

### 1) Battery Voltage Input



HGM400 series controller can suit for widely range of battery voltage DC(8~35)V. Negative of battery must be connected with the engine shell. The diameter of wire which from power supply to battery must be over 1.5mm<sup>2</sup>. If floating charge configured, please firstly connect output wires of charger to battery's positive and negative directly, then, connect wires from battery's positive and negative to controller's positive and negative input ports in order to prevent charge disturbing the controller's normal working.

## 2) **Speed Sensor Input**

Speed sensor is the magnetic equipment which be installed in starter and for detecting flywheel teeth. Its connection wires to controller should apply for 2 cores shielding line. The shielding layer should connect to No. 1 terminal in controller while another side is hanging in air. The else two signal wires are connected to No.1 and No.17 terminals in controller. The output voltage of speed sensor should be within AC(1~24)V (effective value) during the full speed. AC12V is recommended (in rated speed). When install the speed sensor, let the sensor is spun to contacting flywheel first, then, port out 1/3 lap, and lock the nuts of sensor at last.

## 3) **Output And Expansion Relay**

All outputs of controller are relay contact output type. If need to expand the relays, please add freewheel diode to both ends of expand relay's coils (when coils of relay has DC current) or, add resistance-capacitance return circuit (when coils of relay has AC current), in order to prevent disturbance to controller or others equipment.

## 4) **AC Input**

HGM400 series controller must be connected to outside current transformer. And the current transformer's secondary side current must be 5A. At the same time, the phases of current transformer and input voltage must correct. Otherwise, the collected current and active power maybe not correct.

 **CAUTION !** ICOM port must be connected to negative pole of battery.

 **WARNING!** When there is load current, transformer's secondary side prohibit open circuit.

## 5) **Withdraw Voltage Test**

When controller had been installed in control panel, if need the high voltage test,

please disconnect controller's all terminal connections, in order to prevent high voltage into controller and damage it.

### 13 FAULT FINDING

Symptom	Possible Remedy
Controller no response with power.	Check starting batteries; Check controller connection wirings; Check DC fuse.
Genset shutdown	Check the water/cylinder temperature is too high or not; Check the genset AC voltage; Check DC fuse.
Low oil pressure alarm after crank disconnect	Check the oil pressure sensor and its connections.
High water temp. alarm after crank disconnect	Check the temperature sensor and its connections.
Shutdown Alarm During Running	Check related switch and its connections according to the information on LCD; Check auxiliary inputs.
Fail to Start	Check fuel circuit and its connections; Check starting batteries; Check speed sensor and its connections; Refer to engine manual.
Starter no response	Check starter connections; Check starting batteries.
Genset running while ATS not transfer	Check ATS; Check the connections between ATS and controllers.