

# SS350

*Self Excited Automatic Voltage Regulator For Generator  
Compatible with Marathon SE350\**



## *Operation Manual*

S

\* Use for reference purpose only and not a genuine Marathon product.

# 1. INTRODUCTION

**Sensing Input**

Voltage 85 ~ 135 VAC  
 Frequency 50 / 60 Hz, Jumper selectable

**Power Input**

Voltage 180 ~ 265 VAC

**Output**

Voltage Max. 37 VDC @ 110 VAC input  
 Max. 73 VDC @ 220 VAC input  
 Current Continuous 3.5A  
 Intermittent 7A for 10 sec  
 (52 / 105VDC)  
 Resistance Min. 15 ohm Max. 100 ohm

**Voltage Regulation**

< ± 1% ( with 4% engine governing )

**Voltage Build-up**

Residual voltage at AVR terminal > 5 VAC

**Burden**

500VA MAX

**Operating Temperature**

- 40°C to + 60°C

**Storage Temperature**

- 65°C to + 85°C

**External Volts Adjustment**

± 5% with 1K ohm 1 watt trimmer  
 ± 10% with 2K ohm 1 watt trimmer

**EMI Suppression**

Internal electromagnetic interference filtering

**Unit Power Dissipation**

Max. 8 watt

**Under Frequency Protection (Factory Setting)**

60 Hz system presets knee point at 54 ~ 61 Hz  
 50 Hz system presets knee point at 45 ~ 51 Hz

**Dimensions**

99.5mm L \* 67mm W \* 47.5mm H

**Weight**

205g ± 2%

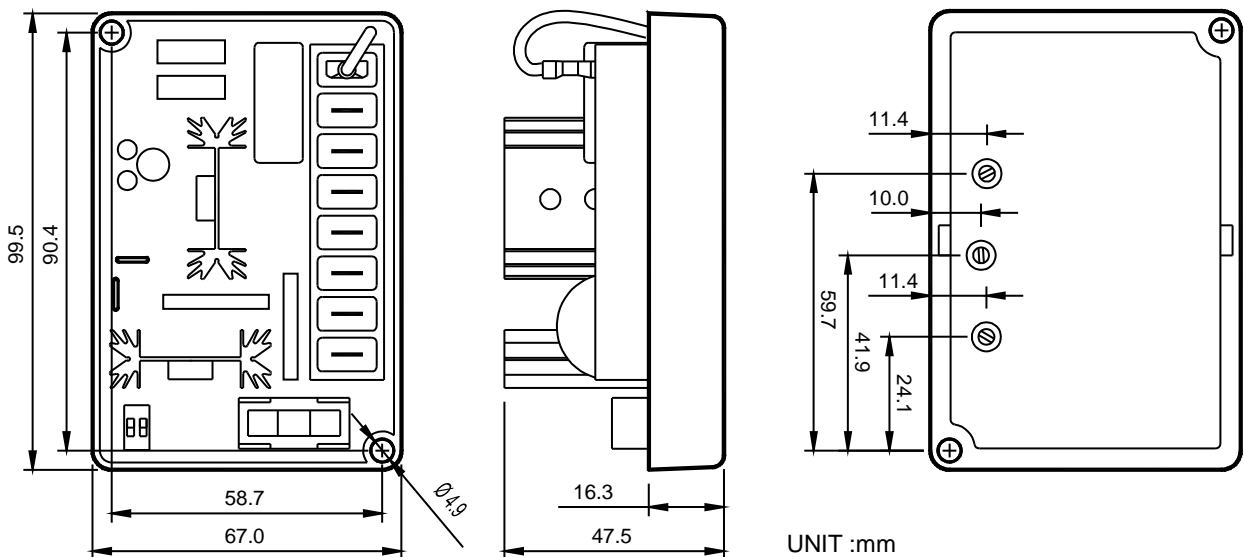

Figure 1 Outline and Drilling Diagram

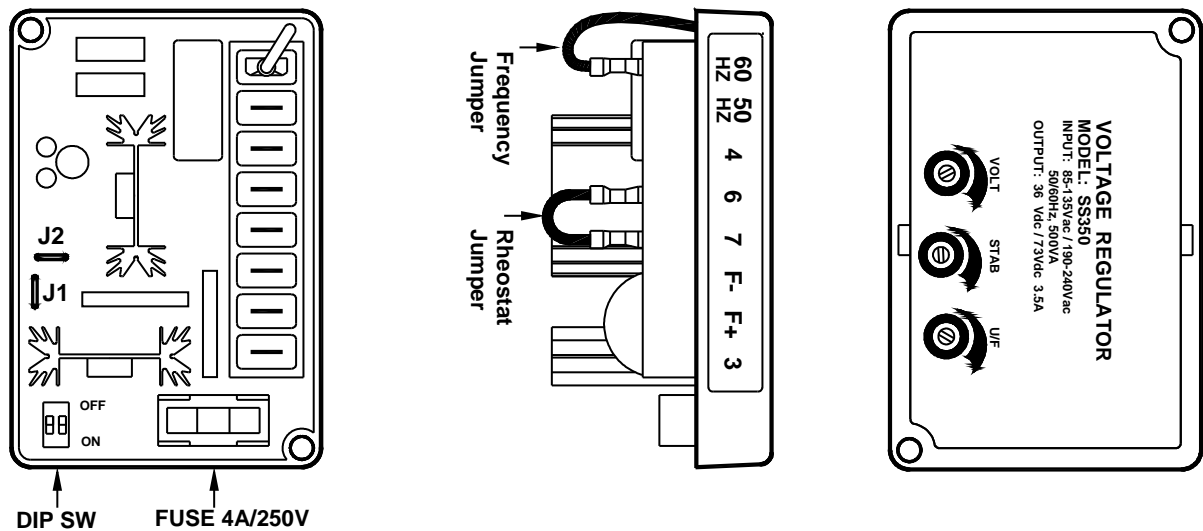

Figure 2 Jumper and Potentiometer Control Locations

## 2. WIRING

### 2.1 Exciter Field Power Circuit

- Connect the regulator wire F+ to the generator F+ or F1 field terminal.
- Connect the regulator wire F- to the generator F- or F2 field terminal.
- See Figure 5~6 for typical connection diagram

#### CAUTION !

The exciter field dc resistance must be 15 ohms or greater and less than 100 ohms.

If the exciter field dc resistance is less than 15 ohms and the full load field current does not exceed the maximum continuous current rating of the controller, a resistor of sufficient wattage must be added in series with the field to increase the total resistance to 15 ohms.

### 2.2 Sensing / Power Input Circuit

Input power and sensing is achieved through terminals 3 and 4. The voltage input requirement of the SS350 is 120 to 240 VAC.

See Figure 5~6.

### 2.3 Voltage Adjustment

The screwdriver adjustable potentiometer adjusts the generator output voltage. Adjustment clockwise increases the generator output voltage.

When using a remote voltage adjust rheostat, remove the jumper wire across terminals 6 and 7 and install a 2000 ohm 1/2 watt (minimum) rheostat. This will give  $\pm 10\%$  voltage variation from the nominal. (For  $\pm 5\%$  voltage variation use a 1000 ohm 1/2 watt rheostat). See Figure 5~6.

### 2.4 Stability Adjustment

- System stability is the ability of the generator to respond to load transients. Decreasing the stability makes the generator less sluggish and faster to respond to load transients. If the stability of the regulator is decreased too much, the generator will tend to hunt under steady state
- Conditions the screwdriver adjustable potentiometer adjusts the system stability Adjustment clockwise.
- Increases the stability. Increasing the stability increases the response time of the generator. Conversely, decreasing the stability decreases the response time of the generator.

### 2.5 V/HZ Roll-Off Frequency Selection

fi The roll off point is the frequency where the generator voltage starts to decrease. This reduces the Kilowatt load to the engine, which allows the engine to recover in speed transient condition. Use jumper to select 50 HZ or 60 HZ. The screwdriver adjustable potentiometer sets the roll-off frequency from 54-61 Hz in the 60 Hz setting or from 45-51 Hz in the 50 Hz setting.

- The SS350 has the roll-off point preset to 58 Hz in the 60 Hz mode and 48 Hz in the 50 Hz mode. To change the roll-off point, adjust engine speed to the desired rated speed. (50 or 60 Hz).
- Set the voltage to the desired setting at rated speed. Adjust engine speed to the desired roll-off point. Turn the potentiometer counterclockwise until the voltage starts to drop off. Then adjust the potentiometer clockwise until the voltage returns to rated voltage. Re-adjust engine speed to rated speed.

## 2.6 Corner Frequency Jumper

Regulator are delivered with the Corner Frequency Jumper set for 60 hertz operation. This gives a corner frequency of 55 hertz. For 50 hertz operation and a corner frequency of 45 hertz, the Corner Frequency Jumper must be moved to the 50 Hz terminal.

## 2.7 Voltage Adjust Rheostat Jumper

- Rheostat Jumper connected across terminals 6 and 7. This enables adjustment of the generator output voltage rheostat. A 1000 ohm, half-watt rheostat will provide adequate voltage adjustment range for most applications. Figure 5-6 shows the proper remote rheostat connections.
- The SS350 potentiometer controls are accessible through the controller front panel and are shown in Figure 2.

## 2.8 Sensing voltage selector DIP switch

2P DIP switch on for 120Vac generator system

2P DIP switch off for 240Vac generator system

## 2.9 Stability Selection

When excitation under voltage, it can result in insufficient adjustment range for stability adjustment and when excitation over voltage, the response from the AVR becomes sluggish. The AVR is equipped with 2 bridging wires J1 and J2 to help improve this.

- If the unloaded excitation voltage is less than 7 VDC, please cut open the J2 red wires
- If the unloaded excitation voltage is greater than 25 VDC, please cut open the J1 white wires.

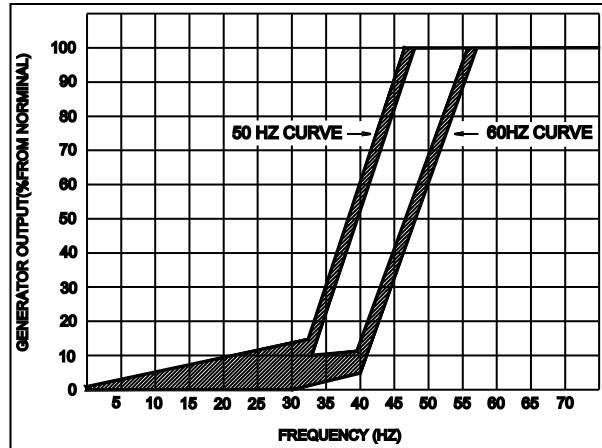

Figure 3 Frequency Compensation Curves

### FREQUENCY COMPENATION (See Figure 1)

1. The frequency compensation characteristic of Figure 1 used to improve system load pickup performance by restraining voltage recovery until frequency has also started to recover.
2. The regulator is shipped from the factory set at a 45 Hz "corner frequency" for 50 Hz systems. For 60 Hz systems, a 55 Hz corner frequency is achieved by removing the "50-50" external link.

## 3. OPERATION PROCEDURE

### 3.1 Test the AVR

Complete the following steps before proceeding with system start-up.

1. Connect the Analog Voltage Controller as shown in the operational test diagram of Figure 8. Do not apply power. Ensure that the light bulbs are rated for 120 volts and less than 100 watts. Figure 4. Operational Test Diagram.
2. Adjust the Regulator voltage adjust potentiometer and remote voltage adjust rheostat (if used) fully counterclockwise.
3. Apply 240 Vac, 60 Hz power to the controller. The light bulbs should flash momentarily.
4. Slowly adjust the controller's voltage adjust potentiometer clockwise.

### RESULT :

1. Before minimum luminance is reached, the light bulbs should attain maximum luminance to signify the regulation point.

- 
2. At the regulation point, a small change in the voltage adjust potentiometer or rheostat position should turn the light bulbs on or off.

### 3.2 Preliminary Setup

Complete the following steps before proceeding with system start-up.

- Verify that the Regulator specifications conform with the requirements of the generator system.
  - Ensure that the controller jumpers and dip sw are installed/positioned as follows.
1. If a remote voltage-adjust rheostat will not be used, ensure that the Voltage Adjust Rheostat Jumper is connected across terminals 6 and 7.
  2. If a 55 hertz corner frequency for a 60 hertz system is desired, connect the Corner Frequency Jumper to the 60 Hz terminal. If a 45 hertz corner frequency for a 50 hertz system is desired, connect the Corner Frequency Jumper to the 50 Hz terminal.
- Ensure that the connection between the generator system and the Regulator are correct.
  - Set the regulator voltage control potentiometer fully counter-clockwise and the remote voltage adjust rheostat (if used) to the centered position.
  - Adjust the regulator stability control potentiometer fully clockwise. This provides the most stability and the slowest response.
  - If user-adjustment of the under frequency control potentiometer is required, start with the potentiometer adjusted to the fully counterclockwise position. Then, slowly adjust the potentiometer clockwise to set.

### 3.3 System Start-Up

- Perform the steps under Preliminary Setup.

NOTE :

All AC voltage readings are to be taken with an "average" reading voltmeter.

- Start Prime-mover and bring up to rated speed.
- Generator voltage should build up. If it does not build up, perform the steps under Field Flashing.
- Slowly adjust the regulator voltage control potentiometer (or remote voltage adjust rheostat) until the generator voltage reaches the nominal level. If the voltage does not build up to the rated level:

1. Check the generator output for excessive load or a short circuit.
  2. If a minimal residual of 5 volts is not present, perform the steps under Field Flashing.
    - Apply and remove the generator load to verify stability. If the generator responds too slowly or hunts (oscillates):
    - Check the generator output for excessive load or a short circuit. Adjust the Regulator stability control with no load applied.
    - Check the stability of the governor system.
    - Check regulation under normal operating conditions. If the regulation is poor:
1. Verify that the prime mover is operating at rated speed.
  2. Verify that the voltmeter is connected to the same point as the Regulator sensing.
  3. Use an average-sensing voltmeter (not an rms-sensing voltmeter).
    - Verify the corner frequency setting by slowly reducing the generator frequency until the generator output voltage just starts to decrease. If adjustment of the corner frequency is required:
1. Rotate the under frequency control fully counterclockwise.
  2. Reduce the generator frequency from nominal (either 50Hz or 60Hz) to the desired corner frequency.
  3. Slowly adjust the under frequency control clockwise until the generator output voltage just starts to decrease.

#### CAUTION :

All voltage readings are to be taken with an average-reading voltmeter Meggers and high-potential test equipment must not be used. Use of such equipment could damage the semiconductors contained in the controller.

## 4. FIELD FLASHING

When the regulator is operated with the generator for the first time, the polarity of residual magnetism may be reversed or too small to achieve the necessary build-up voltage for the regulator. If reversing the field connections does not induce build-up, and the residual voltage is less than the specified value of 5 VAC, shut down the Prime-mover and proceed with the following steps :

1. With the Prime-mover at rest and the regulator's field output wires disconnected, apply a DC source ( Not grounded ) of not more than 6-12 VDC with Positive to F+ and Negative to F-, in series with a current-limiting resistor of 3-5 ohms 20 watt. (The set battery is a suitable source.)
2. Allow approximately 3 seconds before removing the DC source.
3. With the voltage regulator disconnected ( wires 3 and 4 ), start the prime mover and measure the " residual " voltage available at the auxiliary winding. If this voltage is greater than 5 VAC, reconnect voltage regulator, and voltage build-up should be successful. If less than 5 VAC is measured, repeat field flashing procedure.

4. If repeating steps a. and b. does not result in generator voltage build-up, and residual is greater than 5 VAC, replace voltage regulator.

**WARNING**

This Automatic Voltage Regulator is not equipped with loss-Sensing Protection function / Over Excitation Protection. An additional Over-Voltage Protection device for load may be required to avoid possible damage to the equipment or severe personal injury or death.

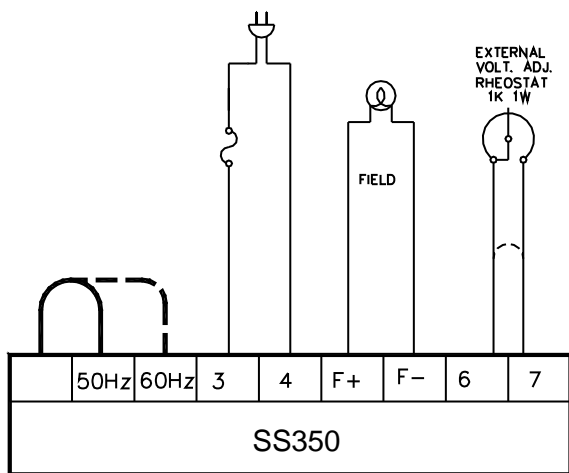

Figure 4 Test Diagram

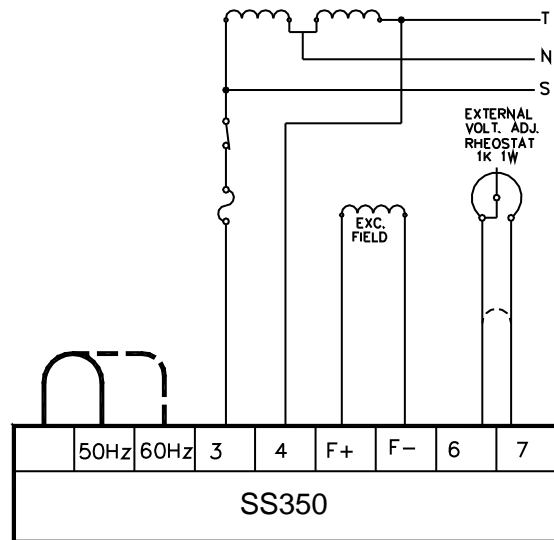

Figure 5 1Phase 220VAC Diagram

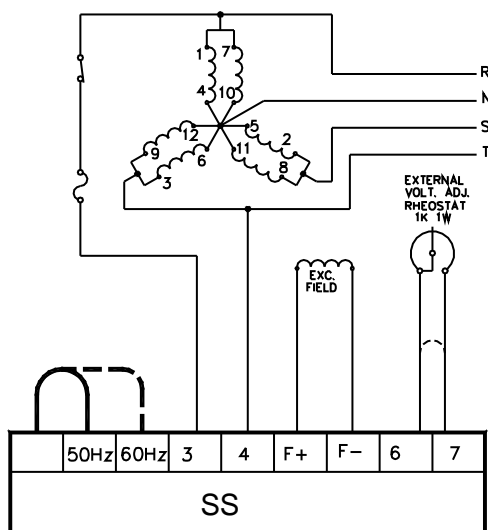

Figure 6 3Phase 220VAC Diagram

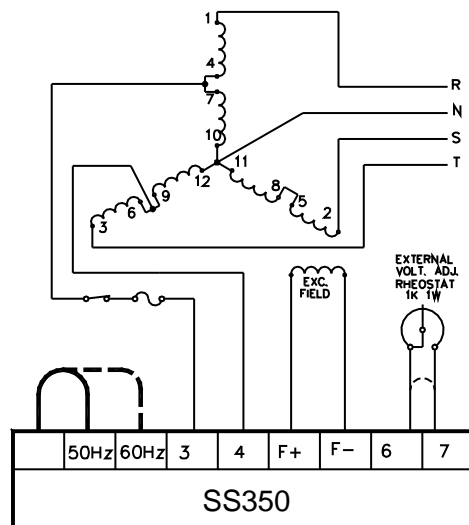

Figure 7 3Phase 380VAC Diagram